

Food Waste Disposer Instruction Manual

See insert for specific information about your new disposer

- NOTE:** This Food Waste Disposer has been designed to operate at 220/240V~, 50/60 Hz household current exclusively. Using any other voltage or Hz adversely affects performance.
- IMPORTANT:** Read all instructions thoroughly. Keep this guide for future reference.
- CAUTION:** Be sure to review SAFETY INSTRUCTIONS FIRST PERTAINING TO A RISK OF FIRE, ELECTRICAL SHOCK OR INJURY TO PERSONS before using disposer.

Record important disposer information here

Model Number*

Serial Number*

*Above information appears on the label affixed to bottom of the disposer. For your convenience, write down the model and serial numbers prior to installation.

IMPORTANT SAFETY INSTRUCTIONS

INSTRUCTIONS PERTAINING TO A RISK OF FIRE, ELECTRIC SHOCK OR INJURY TO PERSONS. SAVE THESE INSTRUCTIONS.

WARNING – When using electrical appliances, basic precautions should always be followed, including the following:

1. Read all instructions before using the appliance.
2. To reduce the risk of injury, close supervision is necessary when an appliance is used near children.
3. Do not put fingers or hands into a waste disposer.
4. Turn the power switch to the off position before attempting to clear a jam or remove an object from the disposer.
5. When attempting to loosen a jam in a waste disposer, use a long wooden object such as a wooden spoon or the wooden handle of a broom or mop.
6. When attempting to remove objects from a waste disposer use long-handled tongs or pliers. If the disposer is magnetically actuated, non-magnetic tools should be used.
7. To reduce the risk of injury by materials that may be expelled by a waste disposer, do not put the following into a disposer: clam or oyster shells; caustic drain cleaners or similar products; glass, china or plastic; large whole bones; metal, such as bottle caps, tin cans, aluminum foil or utensils; hot grease or other hot liquids; whole cornhusks.
8. When not operating a disposer, leave the stopper in place to reduce the risk of objects falling into the disposer.
9. DO NOT operate disposer unless splash guard is in place.
10. For proper grounding instructions see the ELECTRICAL CONNECTION portion of this manual.
11. **Installation of this appliance must be done in accordance to local plumbing codes and laws.**
12. If the supply cord is damaged, it must be replaced by the manufacturer, its service agent, or authorized person in order to avoid hazard.
13. This appliance is not intended for use by persons (including children) with reduced physical, sensory or mental capabilities, or lack of experience and knowledge, unless they have been given supervision or instruction concerning use of the appliance by a person responsible for their safety.
14. Children should be supervised to ensure that they do not play with the appliance.



IM-UK-INTL-121

1. REMOVAL OF OLD UNIT

TYPICAL INSTRUCTIONS, YOUR MODEL MAY VARY.

Before starting this step, turn off electrical power at the circuit breaker or fuse box. Unplug disposer.

If your old mount is the same type as the mount on your new disposer, just reverse the assembly instructions found in section 3. If your new mount system is different, follow these instructions:

- A. Use a pipe wrench to disconnect drain line where it attaches to disposer discharge elbow (see 1A).
- B. Remove disposer from sink flange by turning mount ring to the left clockwise (see 1B). If you are unable to turn the mount ring, tap on one of the extensions from the ring with a hammer. Some mounting systems have tubular extensions. Inserting a screwdriver into one tube will provide additional leverage for turning the mount ring (see 1B). Some disposers may require the removal or loosening of nuts from the mount screws (see 1C). Some disposers may require the removal of a clamp.

Caution: Be sure to support the disposer while performing this step or it may fall when the mounting ring is disconnected from the mounting assembly.

- C. To remove remaining mount system from the sink, loosen mount screws, push mount ring up. Under it is the snap ring. Use screwdriver to pop off ring (see 1D). Remove mount ring, protector ring and gasket from sink flange. Some mounts will require the unscrewing of a large ring holding the sink flange in place. Pull sink flange up through sink and clean off old putty from sink.

IMPORTANT: This is a good time to clean out the trap and drain lines by running a drain auger or plumber's snake before installing your new disposer.

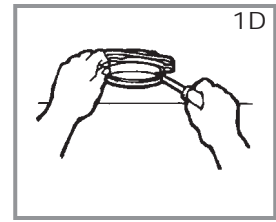
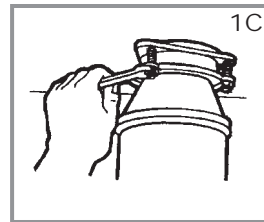
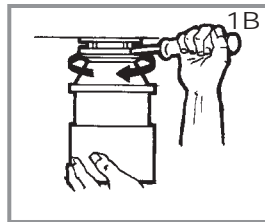
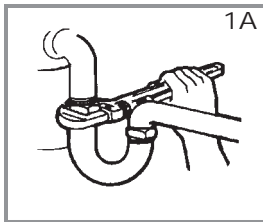

2. DISHWASHER CONNECTION

If you are utilizing a dishwasher, complete the following procedure. If dishwasher is not to be connected go on to section 3.

- A. Using a drill. Drill out the entire plug. (see 2A) When knock out plug falls into disposer, you may remove it or grind it up when the disposer is used. This will not damage the disposer in any way, but may take some time to grind).
- B. Connect dishwasher hose (see 2B) using hose clamp. Make sure all plumbing connections are tight and in accordance with all plumbing codes and ordinances. Run water and check for leaks.

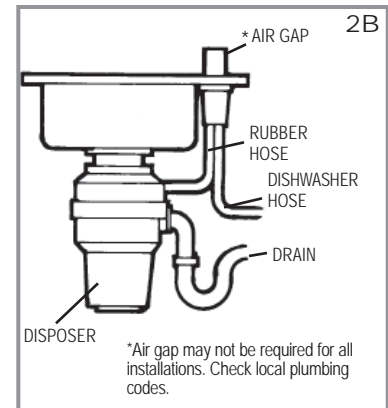
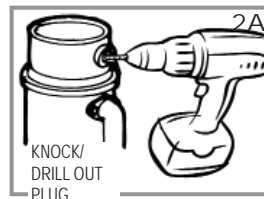

3. INSTALLATION OF MOUNTING ASSEMBLY

READ COMPLETELY BEFORE STARTING

NOTE: Pay close attention to the order of mount assembly parts, as they have been correctly assembled by the factory (see 3A). Also, reference the cushion mount detail in illustration 3G for the proper position of the cushion mount.

NOTE: Try practicing this assembly before you get under the sink to get the "feel" of how the parts fit together.

- A. Disassemble mount assembly from disposer by turning mount ring to the left (clockwise) and remove.

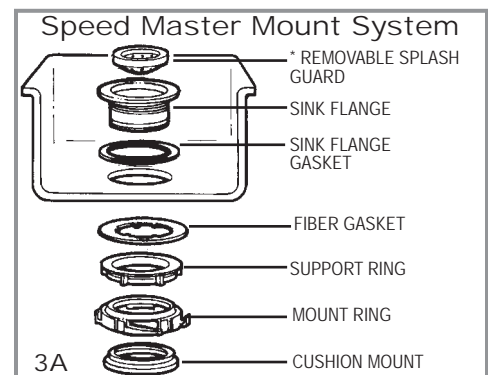

SPEED MASTER MOUNT SYSTEM

- B. Raise mount ring toward top of sink flange. Remove cushion mount. Remove mount ring. You may want to practice installing the cushion mount at this point before you are under the sink. See paragraph H. Also see the "Important Notice: Cushion Mount Detail."
- C. Unscrew support ring from sink flange and remove fiber gasket. You are now left with sink flange and rubber gasket.
- D. **The rubber gasket is used instead of plumbers putty or silicon with stainless steel sinks. Other sinks will require putty.**
- E. If no putty is used, insert sink flange through rubber gasket into sink opening. Do not rotate sink flange once it is seated.
- F. If you use putty instead of the gasket, form a ring around underside of sink flange (see 3D). Insert flange into sink opening, press down hard to squeeze out excess putty (see 3B). From under sink, trim off excess putty flush with bottom edge of sink opening.
- G. From underneath sink, slip fiber gasket onto exposed sink flange. With arrows pointing up, screw support ring onto the sink flange, hand tighten until the sink flange will not move. At this point you may want to insert stopper in sink and fill with water to check sink flange seal and ensure there are no leaks.
- H. Place mount ring over sink flange and hold in place while installing cushion mount (large side down) so the groove on the inside of cushion mount fits over lip on sink flange, similar to putting the lid on a plastic container (see 3E, 3F & 3G). Please read important notice below.
- I. The disposer must be installed so that the reset button is readily accessible.

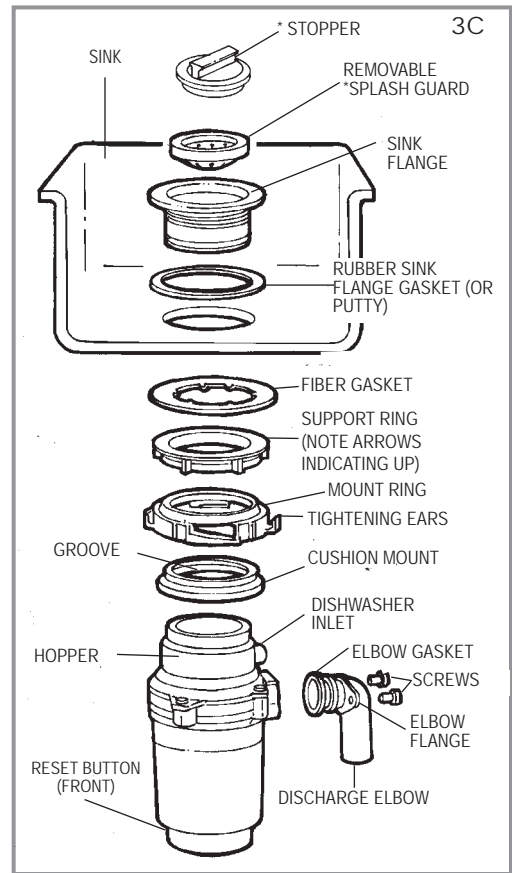
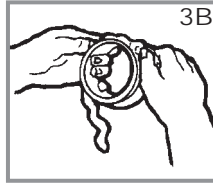

* Stopper & Splash Guard
not used with Batch Feed model

IMPORTANT NOTICE: CUSHION MOUNT DETAIL

When the cushion mount is installed correctly, the lip of the sink flange fits into the groove on the inside of the cushion mount and mount ring can be pulled downward over cushion mount and will be free to rotate. The bottom bead of the cushion mount acts as a gasket between the bottom of the sink flange and the top of the disposer. See illustration 3G.

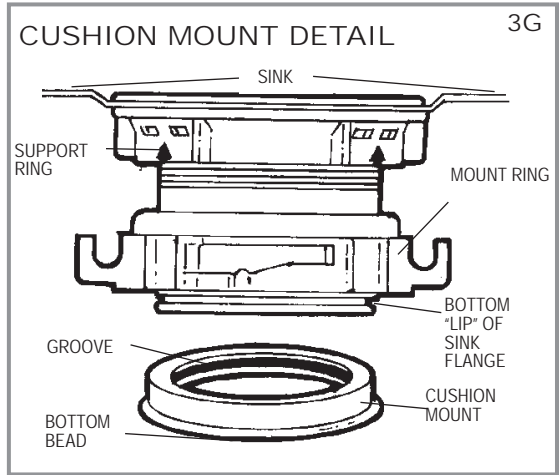
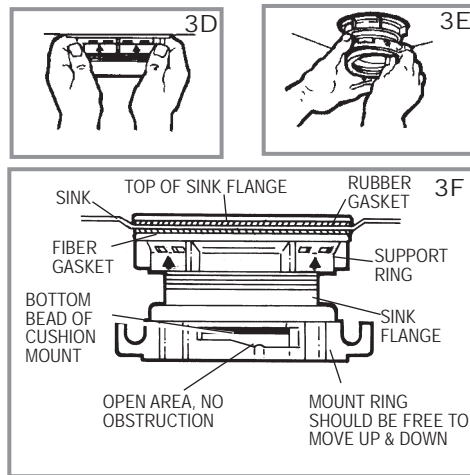

4. ELECTRICAL CONNECTIONS

WARNING: THIS APPLIANCE MUST BE EARTHED. IN THE EVENT OF A MALFUNCTION, EARTHING PROVIDES A PATH OF LEAST RESISTANCE FOR THE ELECTRICAL CURRENT, THUS REDUCING THE RISK OF ELECTRICAL SHOCK.

The rating for these disposers are 220/240V~, 50/60 Hz and they should be connected to a main distribution board or consumer unit.

Prior to connecting the electrical supply, the installer must be thoroughly familiar with electrical power and procedures. If the installer is not, an electrician should be contacted.

WHEN USING THE ATTACHED PRE-WIRED MOLDED PLUG AND LEAD (SEE 4A).

These disposers are engineered to be connected to a 220/240V--50/60 Hz electrical supply through the attached three-pin plug and into a wired socket. The disposer must be protected by a BS 1363 13 Amp fuse. The fuse is included within the molded plug and lead, attached to the disposer.

The 13 Amp double pole switched spur switch should be positioned higher than the sink countertop and at a minimum of one meter from the side of the sink, away from water splashes and out of the reach of children. This spur switch must be a double pole with at least 3mm contact separation in each pole. 20 Amp DP switches BS 3676 meet this condition.

To avoid accidentally leaving the disposer running, a switch with a neon indicator lamp is suggested. A 13 Amp ASTA approved fuse, to BS 1363 must be fitted in the fuse carrier of this spur switch.

ELECTRICAL CONNECTIONS:

Simply insert the plug into the socket wired as previously described.

WHEN NOT USING THE PRE-WIRED PLUG BUT WIRING DIRECT WITH FIXED WIRING (SEE 4B).

The switches used must be double pole type and have at least a 3mm contact separation in each pole (20 Amp DP switches to BS 3676 meet this requirement).

Prepare the tips of the wires of the electrical lead and attach to the junction box. Disconnect the junction box from the electrical supply before making the following connections:

The green and yellow wire must be connected to the terminal marked in one of the following ways:

- with the letter "E"
- by the earth symbol (\perp)
- coloured green or green and yellow.

The brown wire must be connected to the terminal that is marked with the letter "L".

The blue wire must be attached to the terminal that is marked with the letter "N".

(NOTE: As your disposer has a molded plug on the lead and the plug is not to be used, cut it off and dispose of it wisely. A molded plug with a loose lead with disconnected wires can be hazardous as an electrical shock hazard could occur should such a plug be inserted into a 13 Amp socket anywhere within the home.)

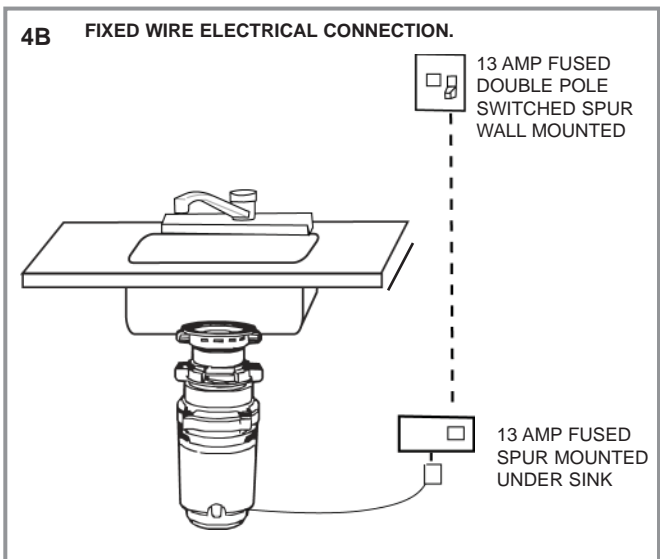
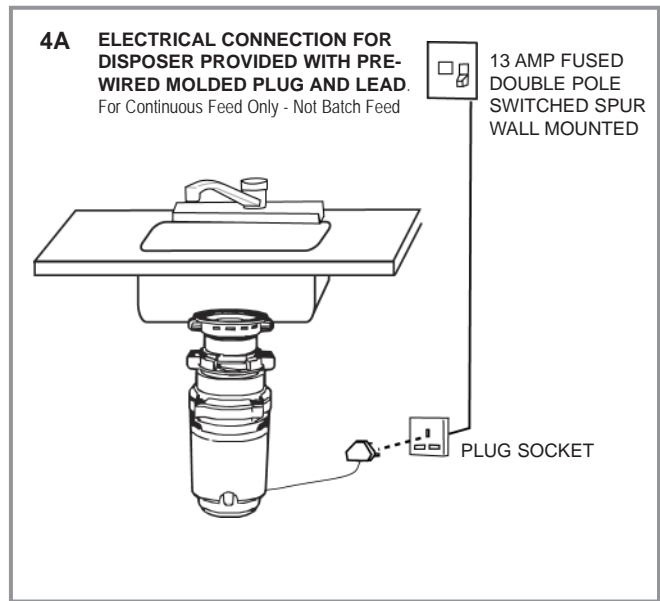

IS THE DISPOSER EARTHED?

WARNING: THIS APPLIANCE MUST BE EARTHED.

In the event of a malfunction or breakdown, earthing reduces the risk of shock. This disposer must be connected to an earthed, metal, permanent wiring conductor and connected to the equipment earthing terminal or lead on the disposer.

GROUNDING INSTRUCTIONS

FOR WASTE DISPOSERS EQUIPPED WITH A GROUNDED PLUG-IN POWER CORD.

- B. This appliance must be grounded. In the event of a malfunction or breakdown, grounding provides a path of least resistance for electric current to reduce the risk of electric shock. This appliance is equipped with a cord having an equipment-grounding conductor and a grounding plug. The plug must be plugged into an appropriate outlet that is properly installed and grounded in

accordance with all local codes and ordinances. If the supply cord is damaged it must be replaced by the manufacturer, its service agent or similarly qualified person in order to avoid a hazard. The appliance must be installed so that reset button is readily accessible.

5. ATTACHING DISCHARGE ELBOW

- A. Connect waste elbow to the disposer (see 5A), proceed to step 6 and then connect bottom of the elbow by tightening the slip nut (see 5B).
- B. If you are connecting to a dishwasher, return to section 2B. If not, make sure all plumbing connections are tight and in accordance with all plumbing codes and ordinances. Run water and check for leaks.

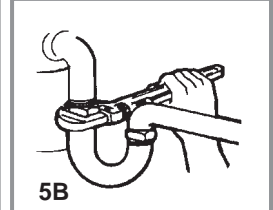
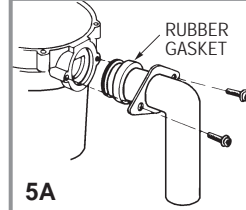

6. CONNECTING DISPOSER TO MOUNT ASSEMBLY

- A. Line up disposer under mounting assembly. Guide hopper projections into mount ring slots. Turn mount ring about 1/4" to right so that disposer is temporarily supported (see 6A).
- B. Turn mount ring and disposer until disposer elbow lines up with trap (see 6B).
- C. Turn mount ring to the right (counter-clockwise) until it reaches the locking position as shown (6D). Hopper projections must be to extreme left of mounting slots (see 6C & 6D).
- D. If mount ring is hard to turn, you may add a small amount of petroleum jelly or liquid soap to hopper projections. Run water and check for leaks.

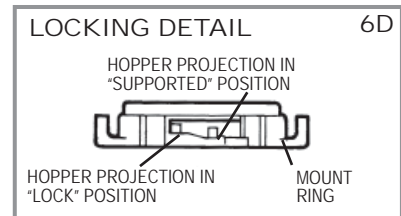
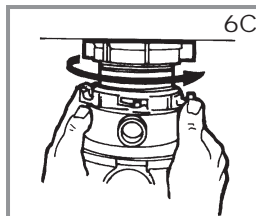
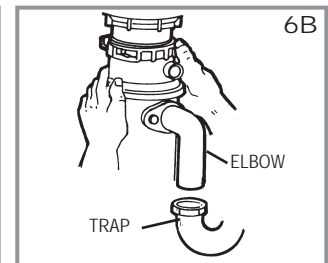
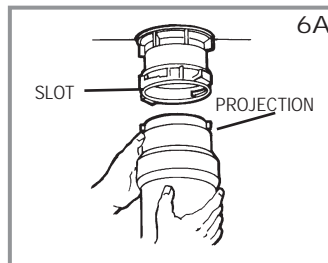

7. OPERATING INSTRUCTIONS

The Anti-Jam Swivel Impellers make a clicking sound as they initially swing into place. This indicates normal operation.

- A. Remove sink stopper. Turn on a medium flow of cold water.
- B. Turn switch to ON position; your motor is turning at full speed and ready to use.
- C. Scrape in food waste. Down the drain go table scraps, peelings, rinds, seeds, pits, small bones and coffee grounds. To speed up food waste disposal, cut or break up large bones, rinds and cobs. Large bones and fibrous waste require considerable grinding time and are more easily thrown away with other trash. Do not be alarmed that the disposer slows down while grinding. The

disposer is actually increasing torque (grinding power) and is operating under normal conditions.

- D. Before turning disposer off, let water and disposer run for approximately 15 seconds after shredding or grinding stops. This assures that all waste is thoroughly flushed through trap and drain.
- E. It is not recommended to use hot water while running disposer. Cold water will keep waste and fats solid so disposer can flush away particles.

TIPS FOR SUCCESSFUL OPERATION

- A. Be sure disposer is empty before using your dishwasher so it may drain properly.
- B. You may want to leave the stopper in the drain when not in use to prevent utensils and foreign objects from falling into the disposer.
- C. Your disposer is ruggedly built to give you many years of trouble free service. It will handle all normal food wastes, but it will NOT grind or dispose of such items as plastic, tin cans, bottle caps, glass, china, leather, cloth, rubber, string, clam and oyster shells, aluminum foil or feathers.

8. CLEANING AND MAINTENANCE

DO NOT ATTEMPT TO LUBRICATE YOUR DISPOSER!

The motor is permanently lubricated. The disposer is self cleaning and scours its internal parts with each use.

NEVER put lye, bleach, or chemical drain cleaners into the disposer, as they cause serious corrosion of metal parts. If used, resulting damage

can be easily detected and all warranties are void. Mineral deposits from your water can form on the stainless steel turntable, giving the appearance of rust. DO NOT BE ALARMED, the stainless steel turntables used will not corrode.

TYPICAL INSTALLATIONS

* Dimensions are mm.

Economy	231
Standard	231
Mid-Duty	249
Heavy Duty	255
Deluxe	255
Premium	255
Mid-Duty BF	303
Heavy-Duty BF	310
Deluxe BF	310
Premium BF	310

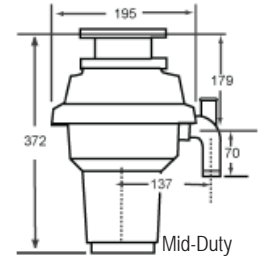
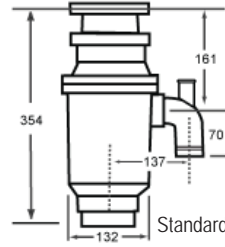
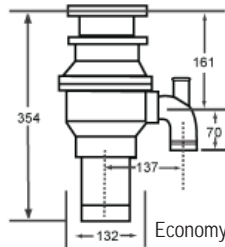
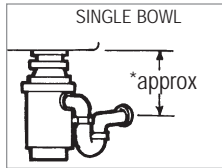

Choice of Trap is Optional.
Bottle Traps are not suitable.

ELBOW DETAIL (ALL MODELS)

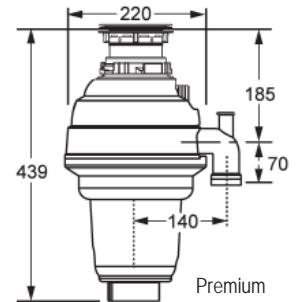
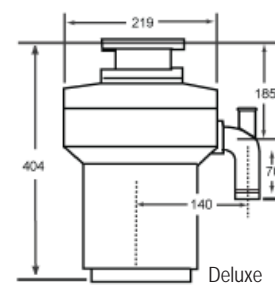
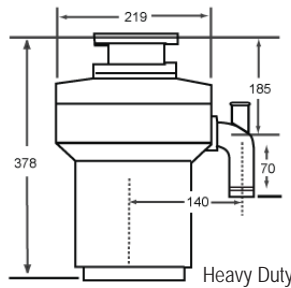
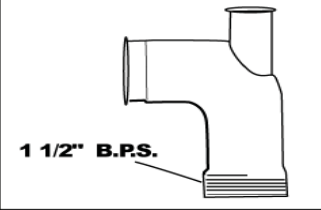

Round Shell Dimensions

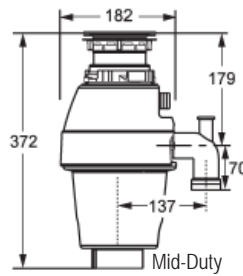
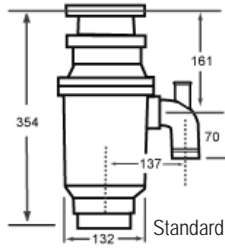
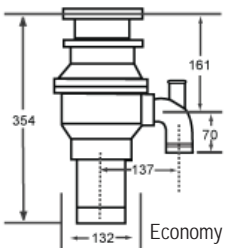

Batch Feed Dimensions

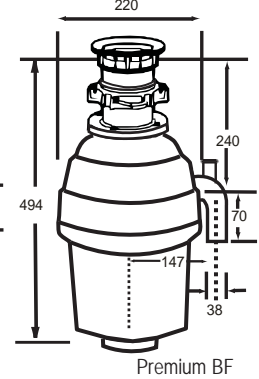
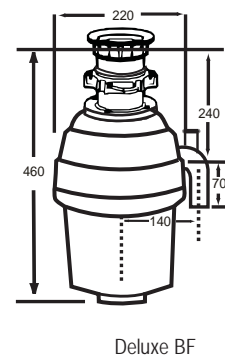
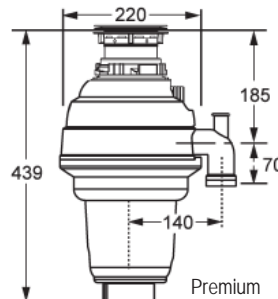
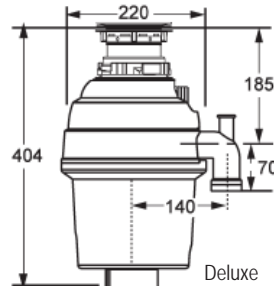
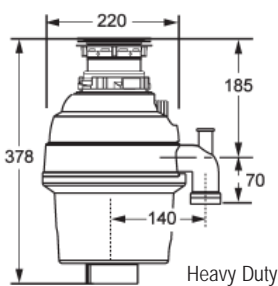
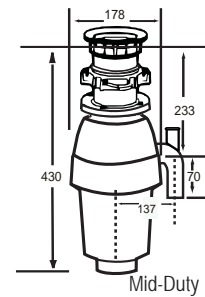

9. TROUBLESHOOTING

Before seeking repair or replacement, we recommend that you review the following:

LOUD NOISES: (Other than those during grinding of small bones and fruit pits): These are usually caused by accidental entry of a spoon, bottle cap or other foreign object. To correct this, turn off electrical switch and water. After disposer has stopped, remove splash guard, remove object with long handled tongs, and replace splash guard.

UNIT DOES NOT START: Unplug power cord or turn either the wall switch or breaker box switch to "OFF" position, depending on your model and wiring configuration. Remove stopper and/or splash guard. Check to see if turntable will rotate freely using a wooden broom handle. If turntable rotates freely, replace splash guard and check reset button to see if it has been tripped. Reset button is red and located on the front of the disposer. Push button in until it clicks and remains depressed.

Reset Button should be pressed only once.

If reset button has not been tripped, check for shorted or broken wire connecting to disposer. Check electrical power switch, fuse box or circuit breaker. If wiring and electrical components are intact, the unit may have internal problems that require service or replacement.

IF TURNTABLE DOES NOT ROTATE FREELY: Turn off disposer, then check for any foreign object lodged between the turntable and grind ring. Dislodge object by rotating table with a wooden spoon or broom

handle (see 9A) and remove object. If no foreign object is present, there may be internal problems.

LEAKS: If the unit leaks at the top, it may be due to:

1. Improper seating of sink flange (gasket centering, putty or tightening).
2. Support ring not tightened properly.
3. Defective or improperly installed cushion mount.

If unit leaks at the waste elbow, leak may be due to improper tightening of elbow flange screws.

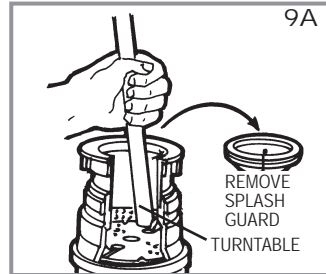

DO NOT PRESS THE RED RESET BUTTON UNLESS POWER IS SWITCHED OFF AT THE POWER POINT.

10. ELECTRICAL INFORMATION

REPLACING THE FUSE IN MOLDED PLUGS:

The correct fuse cover must be refitted when changing the fuse. Remove the fuse cover and slide the fuse out. Replace it with a 13 Amp ASTA fuse (approved to BS 1363). Should the fuse cover be lost or damaged, an exact replacement should be used. These are available from an approved service agent, listed below. Never use the plug without the fuse cover fitted.

If a rewirable plug is to be fitted to the supply lead, it should be connected as follows:

REWIRABLE PLUG FIT INSTRUCTIONS

WARNING: This appliance must be earthed. The wires in the supply lead are coloured in accordance with the following code: Green and Yellow = Earth; Blue = Neutral; Brown = Live.

- When connected to a BS 1363 fused plug, a BS 1362 ASTA approved 13 Amp fuse must be fitted.
- As the colours of the wires in the supply lead of this appliance may not correspond with the coloured markings identifying the terminals in your plug, proceed as follows:
 - The green and yellow wire must be connected to the terminal in the plug which is marked with the letter "E" or by the earth symbol or coloured green or green and yellow.
 - The brown wire must be connected to the terminal which is marked with the letter "L" or coloured red.
 - The blue wire must be connected to the terminal which is marked with the letter "N" or coloured black.

IMPORTANT:

If the supply lead is damaged, it must be replaced by the manufacturer or its service agent.

ANAHEIM MARKETING INTERNATIONAL

4332 E. La Palma Avenue Anaheim, California 92807

Telephone: 714.993.1707 Fax: 714.993.1930

Website: www.AnaheimMarketing.com E-Mail: ContactUs@AnaheimMarketing.com